

9W / 15W

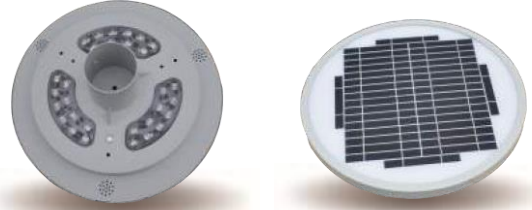

30W

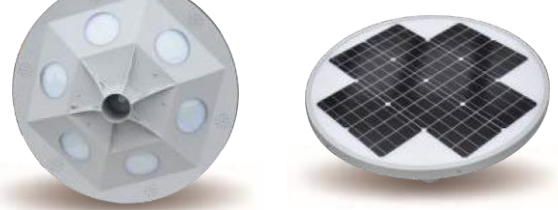

Installation

1. Open the package and check if components are complete as follows:

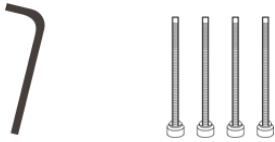

Special tool M8 socket head cap screw

2. Turn on the switch before installation (Light is off when switch pushed in).

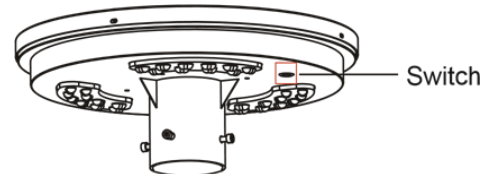

3. Place light into the top of pole and fasten the screw.

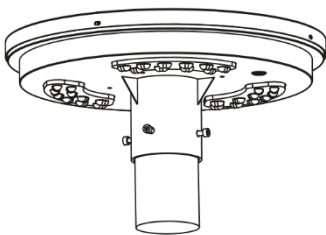

legal Clarification: All technical information and/or products listings and/or technical support, and/or any kind of graphics, illustrations and/or instructions and/or the names, trade names, trademarks, trade symbols, service marks, logos, icons and trade dress of SolarPath Inc or in connection to SolarPath Inc or any of its selling products, contained herein is in the exclusive ownership of SolarPath Inc and may not be alternated and/or used in any manner including but not limited to copy of some or all of the said material by users and/or viewers or any third party for that matter of this document and the website to which it is linked without the express prior written permission of SolarPath Inc. Furthermore, redistribution or any kind of commercial use or alternation or any kind of use other then downloading presented information in some or all contents of downloadable documents, and/or downloadable contents, is strictly prohibited without express written prior permission. All information set out herein is subject to changes as may occur from time to time. SolarPath Inc is not responsible for, and cannot guarantee and shall not be held liable for any information or the accuracy of such in websites that it does not manage.



Notes

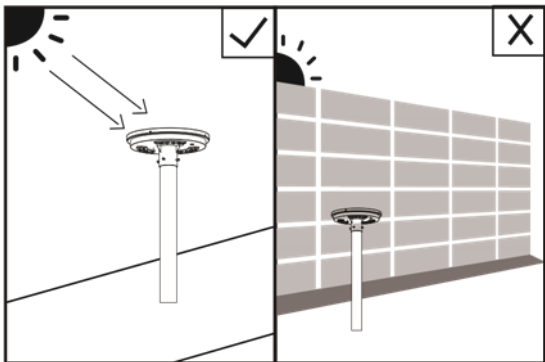
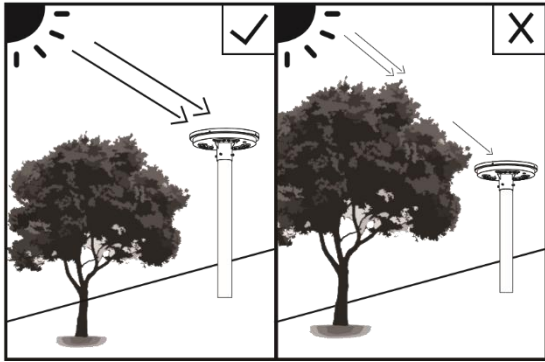

Operation mode

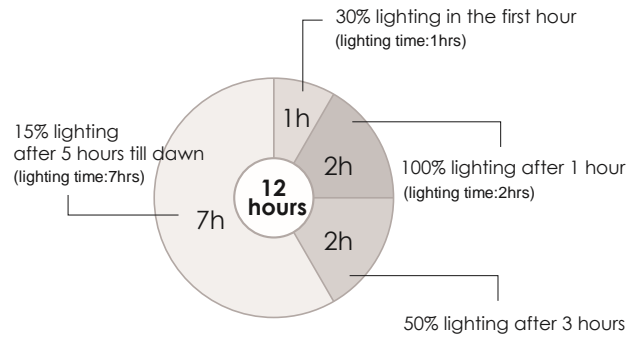

Application



legal Clarification: All technical information and/or products listings and/or technical support, and/or any kind of graphics, illustrations and/or instructions and/or the names, trade names, trademarks, trade symbols, service marks, logos, icons and trade dress of SolarPath Inc or in connection to SolarPath Inc or any of its selling products, contained herein is in the exclusive ownership of SolarPath Inc and may not be alternated and/or used in any manner including but not limited to copy of some or all of the said material by users and/or viewers or any third party for that matter of this document and the website to which it is linked without the express prior written permission of SolarPath Inc. Furthermore, redistribution or any kind of commercial use or alternation or any kind of use other then downloading presented information in some or all contents of downloadable documents, and/or downloadable contents, is strictly prohibited without express written prior permission. All information set out herein is subject to changes as may occur from time to time. SolarPath Inc is not responsible for, and cannot guarantee and shall not be held liable for any information or the accuracy of such in websites that it does not manage.

