

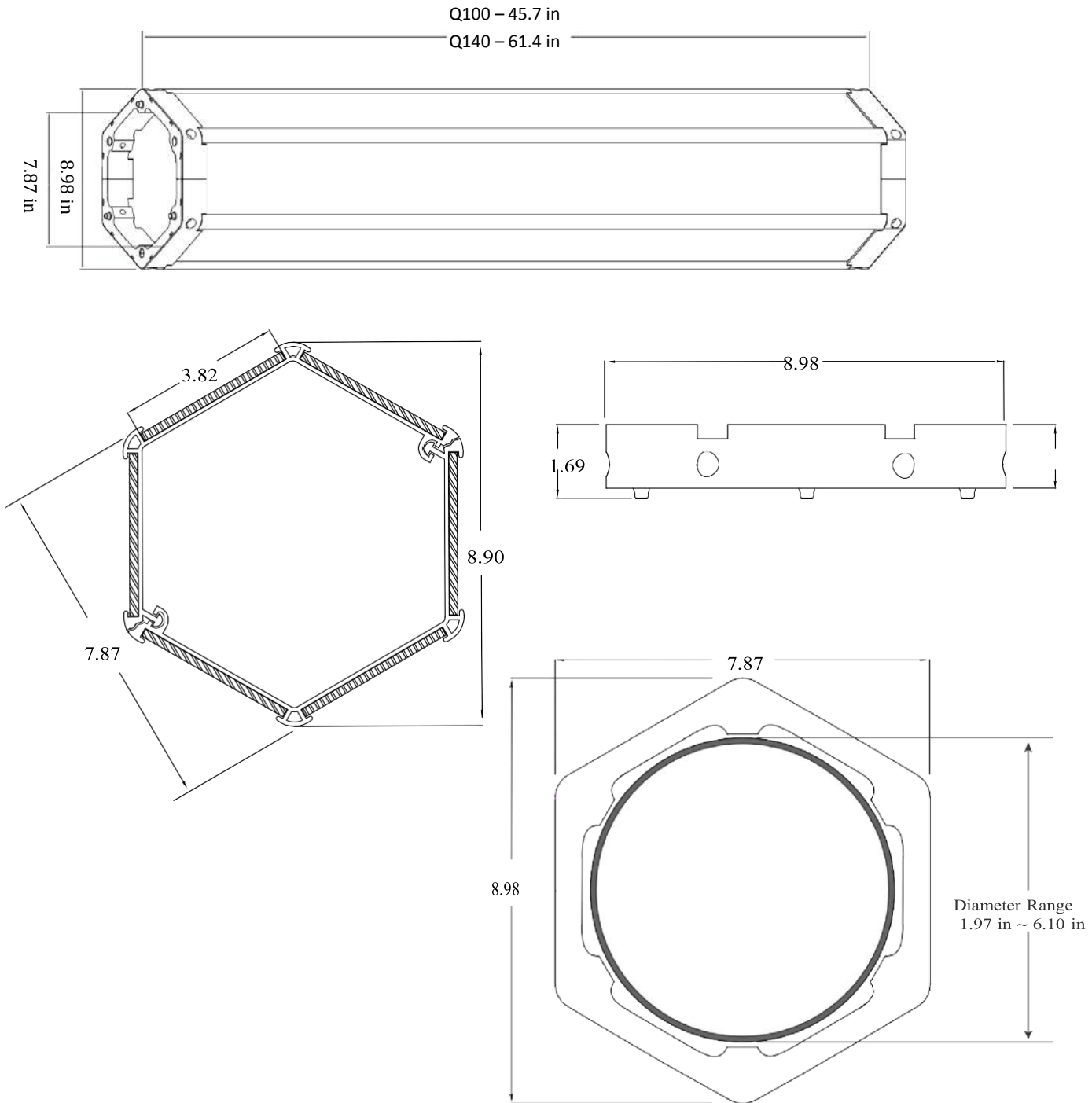

Materials in Package:



Materials in Package



- 1 : All MC4 **male** connector (including master and sub modules) are **positive 18/36V+**.
And all MC4 **female** connector (including master and sub modules) are **negative 18/36V-**.
- 2 : The type of MC4 connectors at two sides of **MASTER MODULE** are exactly same. That is to say: you can use either of two sides to connect to the all in two solar light head or other device in the same way as using regular solar panel.
- 3 : MC4 adapters must be used between two solar cylinders.
- 4 : One mini male connector of master moduler is **positive 18/36V+**. The other side is **negative 18/36V-**. **THEN** accordingly: One mini female connector of sub moduler is **Negative 18/36V-**. And the other mini female connector on the other side is **positive 18/36V+**.
(The polarity mini connectors between sub module and master module are contrary.)
- 5 : **ALL** mini male and female connectors between sub module and master module should be connected to complete the whole system connection.

Required Tools



Electric Allen Wrench for M8 set screws

OR



Allen Wrench for M8 set screws

Connection Between Modules

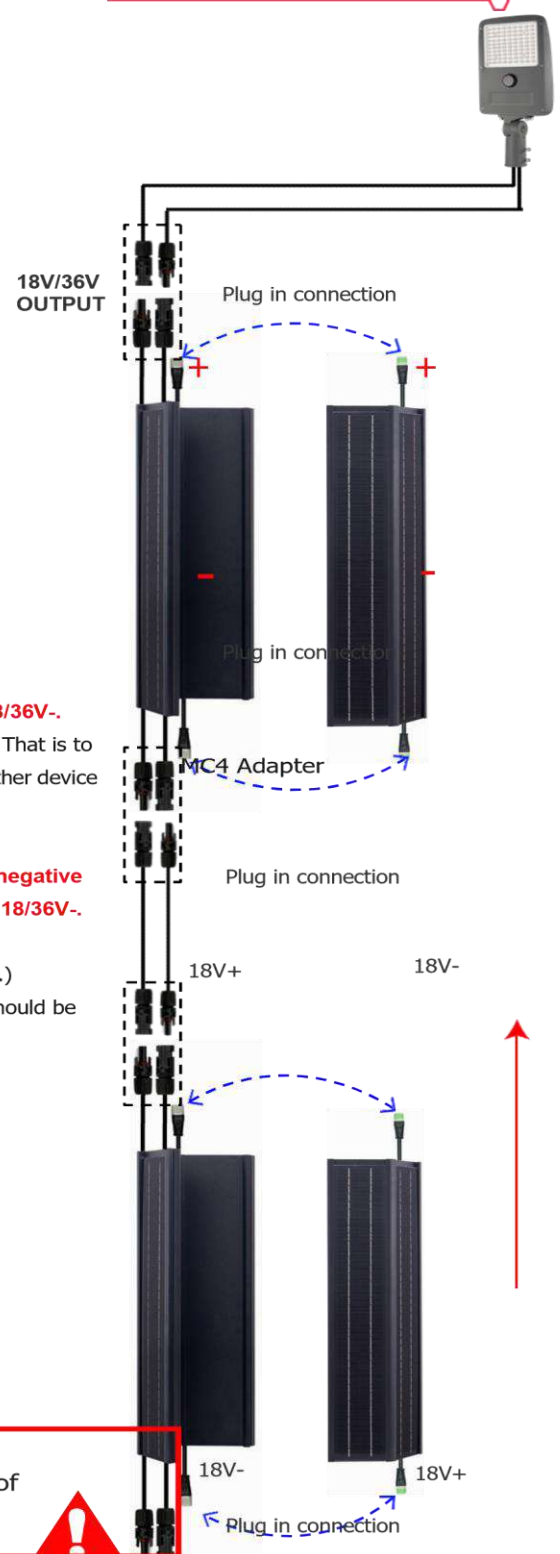

VERY IMPORTANT:

DO NOT CONNECT the MC4 male and female connector of the **LAST MODULE**.
Just leave them there or cut the connectors off.

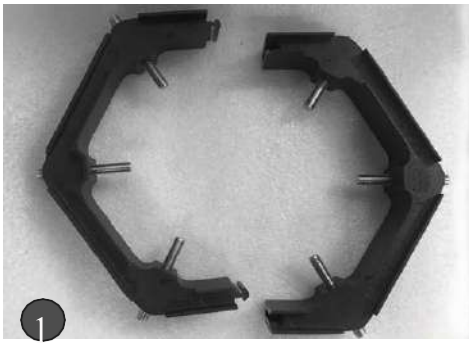

1

Use the screwdriver to fix the screws into the modular bracket at the proper position according to the diameter of the part of the pole where the modular brackets to be mounted.



5

Make sure the brackets are mounted very tight and strong enough, it can hold 110lbs.



8

Connect the male and female mini connectors between sub module and master module.



2

Buckle the modular brackets on the pole, and Lock the two parts as one unit, make sure two parts are at same level (VERY IMPORTANT).



6

Put the first master module on the brackets in the right position.

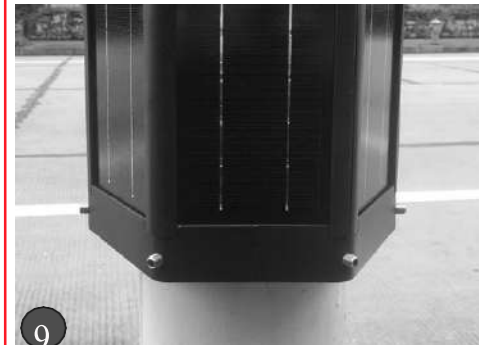

9

After connection of the cables of last step, put down the sub module carefully, and put the two modules on the brackets at the best position.



3

Connect the two parts of brackets and make the junction area flat and without any tilt. This step is very important. or the module will be tilted.



4

Fasten the 6 pieces of screws with driver, make sure the pole is in the exact middle of the brackets.



7

With another person's help, Install the sub module from the top of master module, and slide down the sub module carefully, but hold it when sub module reaches the brackets with 20cm distance.



10

Take out the two MC4 cables from the master module carefully, and connect the MC4 adapter to this MC4 connectors.

Please check the wiring diagram for the details.

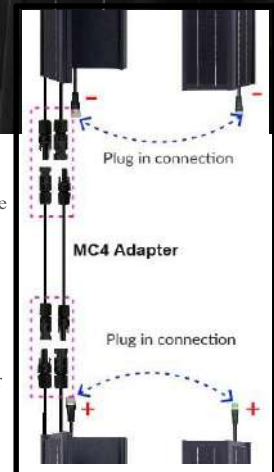



11 Put **second** brackets over the module in opposite direction to the bottom brackets. Install it in the same way as installing the first brackets.



15 Make sure the two MC4 cables are outside through the third brackets. (Ready to install the next modules.)



18 Connect the MC4 connectors and put it back inside of the module tube. (It will be invisible from outside.)

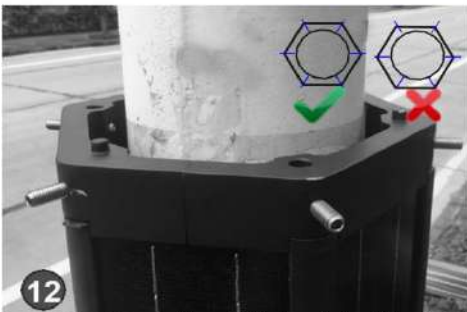

12 Adjust the position of the brackets at the best position. Similarly, let the pole in the middle of the hexagon brackets.



13 Fasten the 6 pieces screws with driver carefully.



16 Put the second master module on the bracket in the same way as **6** mentioned



19 Put the second sub module on the bracket in the same way as **7** mentioned.

Repeat the operations as **8** **9** **10** to complete the pending installation. Finally connect the last two MC4 connectors on top of pole to solar light head directly.



14 Put the third brackets over the second brackets, and take out the two MC4 cables of first modules through the third brackets.
NOTE: Let the two brackets fit snugly through the three positioning holes.



17 Connect the first module to the second module by MC4 plugs directly.

PLUG IN. EASY OPERATION

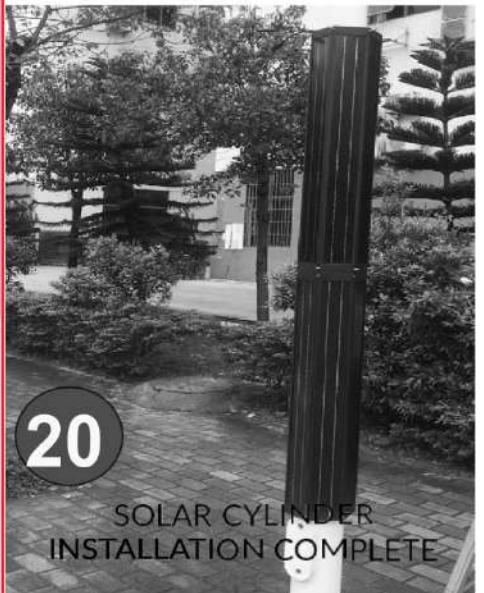
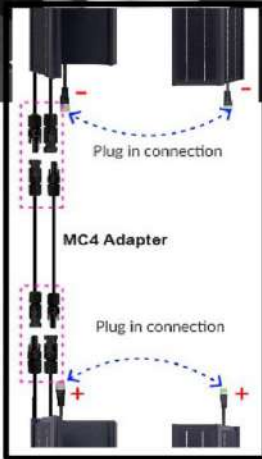

20 SOLAR CYLINDER INSTALLATION COMPLETE